

Catalog Number:	Project Name:	Note:	Date:	Type:
-----------------	---------------	-------	-------	-------

Why stock three different color temperatures when you can have 15-in-1? Portor's retrofit residential downlights are taking the market by storm! Available in 4" and featuring color selectable technology that lets the user choose between 2700K, 3000K, 3500K, 4000K, or 5000K.

Ideal use for residential housings, high-rise condominiums, the healthcare industry, universities/campuses, shopping centers and hospitality.

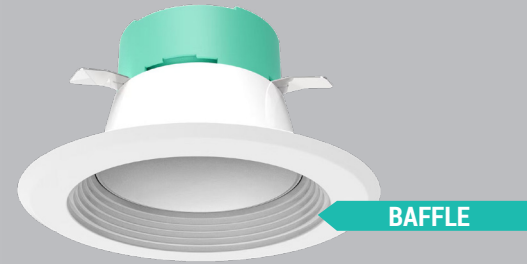

CONSTRUCTION

PC driver housing and aluminum reflector with architectural white finish. Easy clip-in to existing can housing. Standard gasket included to ensure proper seal. E26 base included.

ELECTRICAL

Luminaire is built with the highest quality 120V drivers, ensuring energy efficiency.

ENERGY SAVINGS

80% more energy savings than traditional lamps. Low heat production requires less air-conditioning requirements, further increasing energy cost savings.

DIMMING

Triac dimmable down to 5%. Compatible with most major brands of dimmers.

LISTING

ETL Listed, Energy Star Listed, RoHS

TECHNICAL SPECIFICATION

WATTAGE	6W/8W/10W
CCT	2700K/3000K/3500K/4000K/5000K
CRI	90
DIMMING	Triac dimming
VOLTAGE	120V
POWER FREQUENCY	60 Hz
BEAM ANGLE	100°
POWER FACTOR	>0.9
WORKING TEMPERATURE	-14°F ~ 122°F
IP RATING	IP40, For damp location
WARRANTY	5 year limited (Standard)



DIMENSION

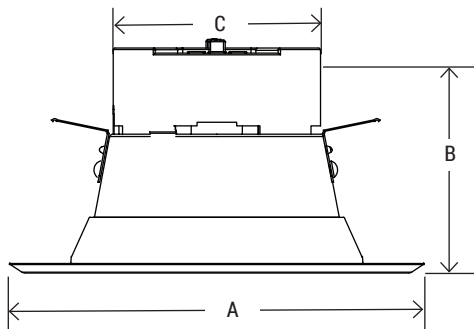





CATALOG NO.	PT-DLR-B-4I-10-5C3P-2
A	5.12"
B	2.77"
C	xx"
Net Weight	.31 lbs
Gross Weight	.42 lbs

Catalog Number:	Project Name:	Note:	Date:	Type:
-----------------	---------------	-------	-------	-------

ORDERING SAMPLE: PT-DLR-B-4I-10-5C3P

PT-DLR	-	B	-	4I	-	10	-	5C3P	-	2	-
Fixture											
Series	Style	Size	Max Wattage	CCT/Wattage	Generation						
PT-DLR	B (Baffle)	4I (4" Aperture)	10 (Wattage)	5C3P (27K/30K/35K/40K/50K) (6W/8W/10W)	2 (2nd Generation)						

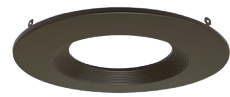
Control/Sensor³	Add-On³	Fixture Add-on³	Other Option³
TEELIO ¹	EM Battery	Trim Ring Replacement	Warranty
<p>__ Blank</p>  <p>PT-BTC-PHA Bluetooth Phase Controller</p>	<p>__ Blank</p>  <p>PT-EMA-25W Low Output Voltage EM Battery Pack (Remote installation)</p>	<p>__ Blank</p>  <p>TR-DLR-4I-BK 4" Black Trim Ring Replacement</p>  <p>TR-DLR-4I-BN 4" Brush Nickel Trim Ring Replacement</p>  <p>TR-DLR-4I-BZ 4" Bronze Trim Ring Replacement</p>	<p>__ Blank (5 year standard)</p> <p>7YR 7-year Limited Warranty</p> <p>10YR 10-year Limited Warranty</p>

COMPATIBLE DIMMERS

LUTRON	LEVITON
<ul style="list-style-type: none"> • CT-600PR • MSCL-0P153MH • DVWCL-153PH • TGCL-153PR • MA-RR • DVCL-153PR • SCL-153PR • P-PKG1W-WH-R • MACL-153MH 	<ul style="list-style-type: none"> • R00-RNL06-TW • R50-IPL06-10M

¹ DOWNLOAD THE TEELIO APP

Download on the App Store | GET IT ON Google Play



³ SOLD SEPARATELY

Catalog Number:	Project Name:	Note:	Date:	Type:
-----------------	---------------	-------	-------	-------

LUMEN PACKAGES

(Delivered lumens are based on the actual IES results)

CATALOG NUMBER	WATTAGE	CCT	DELIVERED LUMENS	EFFICACY (LM/W)
 PT-DLR-B-4I-10-5C3P-2	6W	2700K	535	87
		3000K	558	94
		3500K	570	95
		4000K	573	95
		5000K	565	92
	8W	2700K	684	84
		3000K	717	89
		3000K	741	94
		4000K	744	94
		5000K	722	90
	10W	2700K	807	82
		3000K	845	87
		3000K	881	92
		4000K	879	91
		5000K	839	85



E26 Adapter included for easy retrofitting

WHAT'S IN THE BOX?

- Fixture
- E26 Adapter
- Installation sheet

QTY/CARTON

60
PIECES